

1

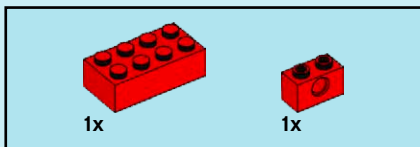

2

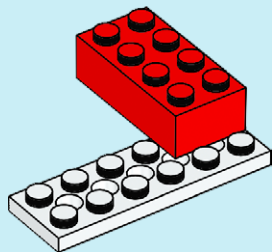

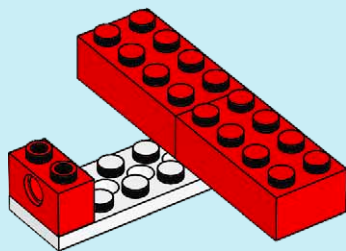
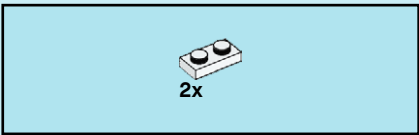

3

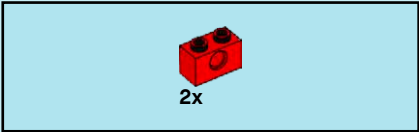
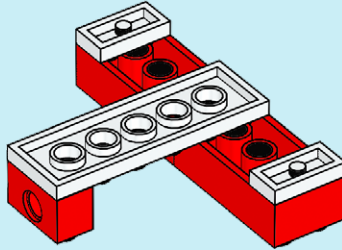

4

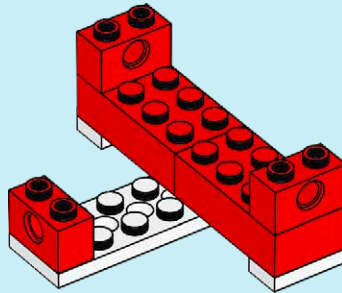
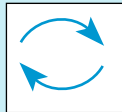

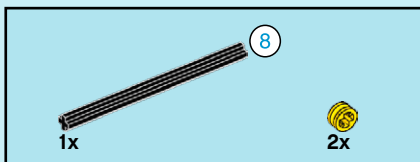

5

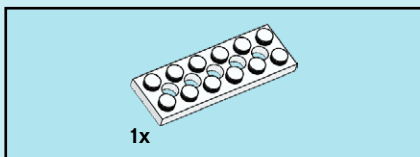
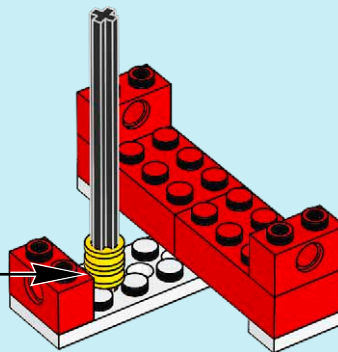
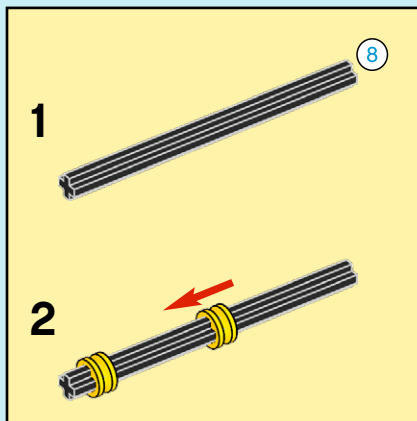

6

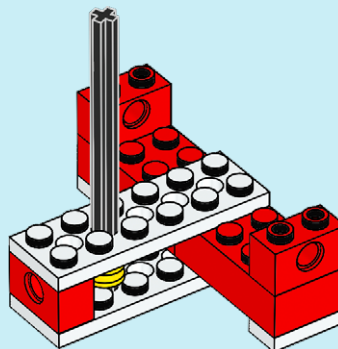



4x

7

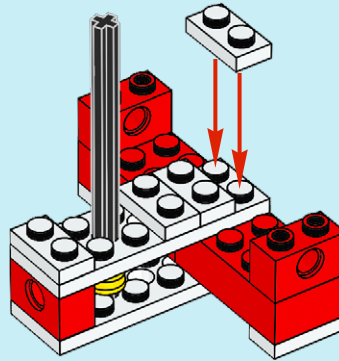

1x



1x

8

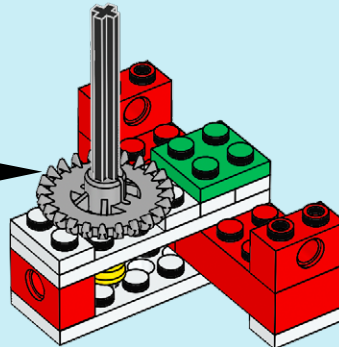
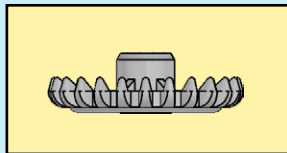

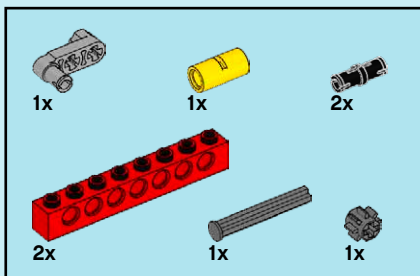

9

1

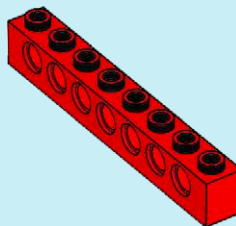

2

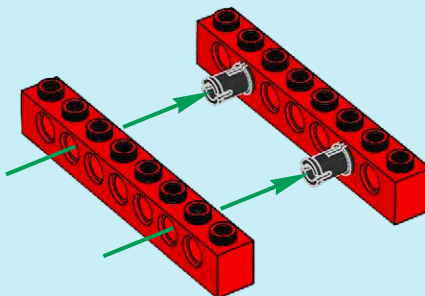

3

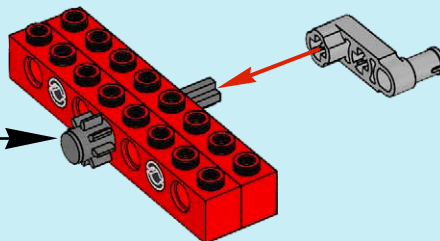
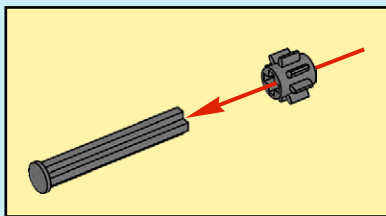

4

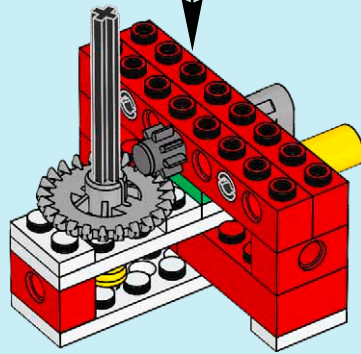
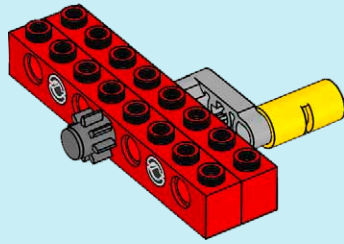

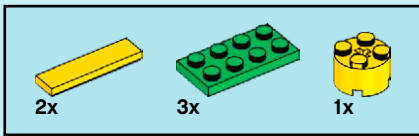

10

1

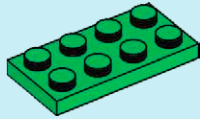

2

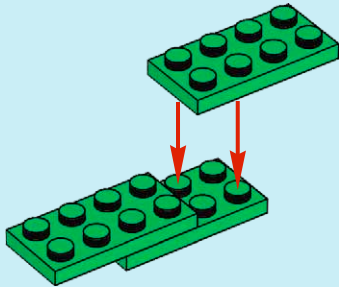

3

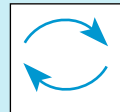
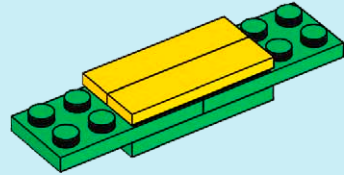

4

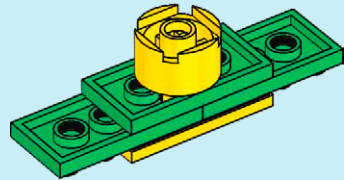

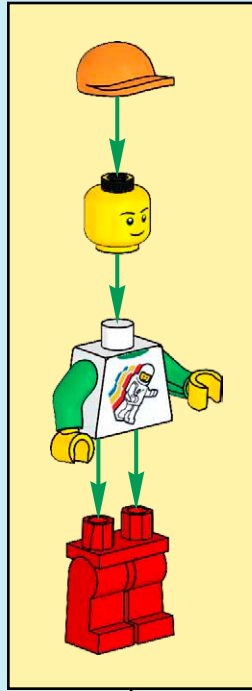
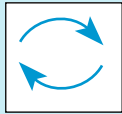

5

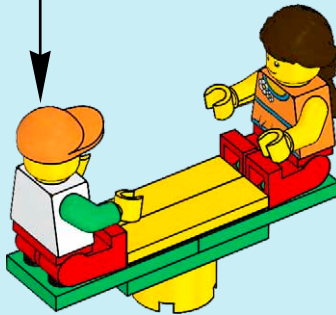

11

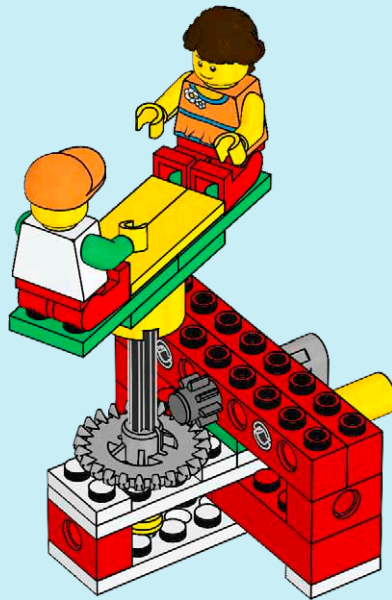

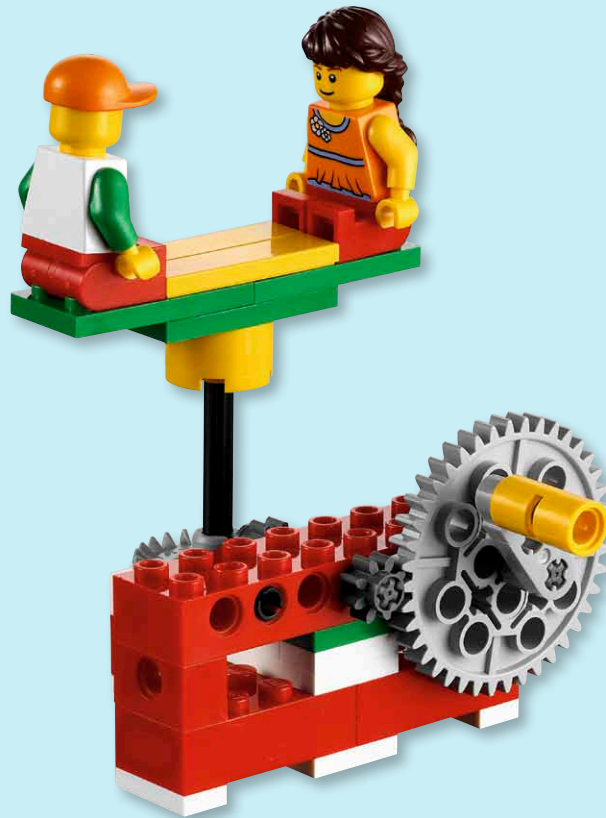

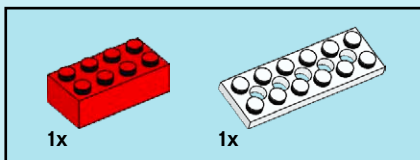

1

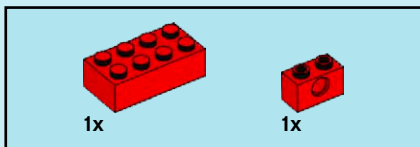
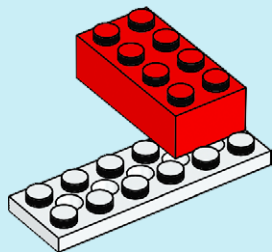

2

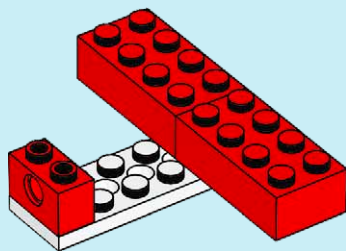

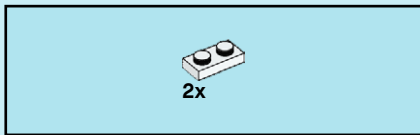

3

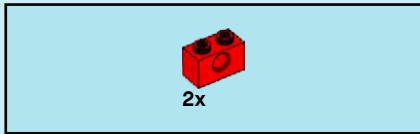
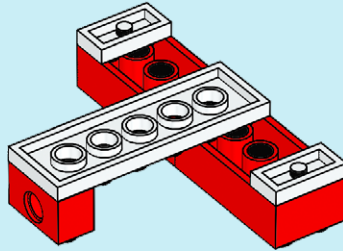
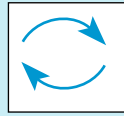

4

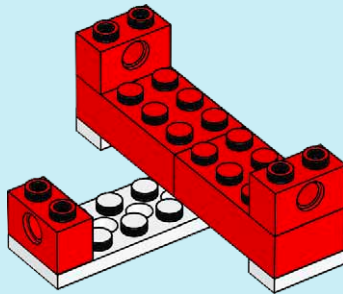
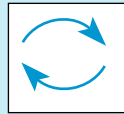

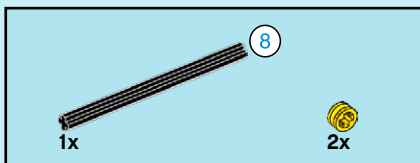

5

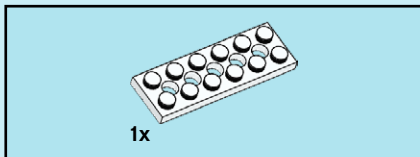
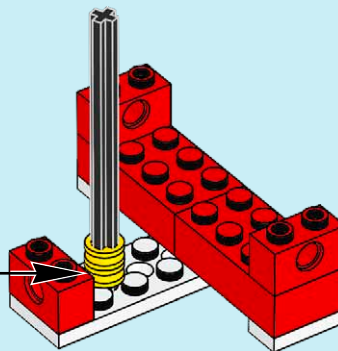
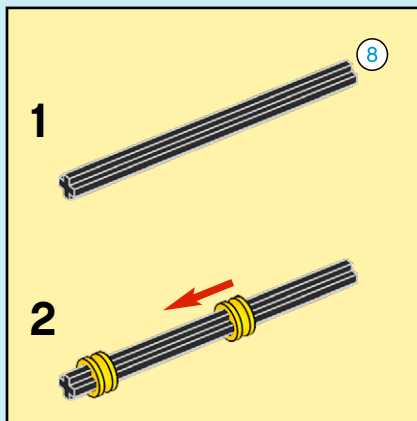

6

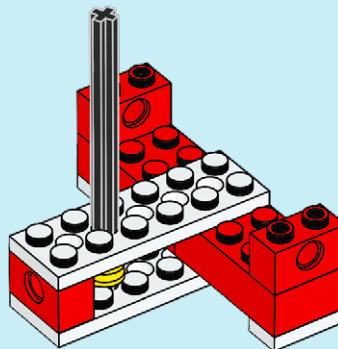

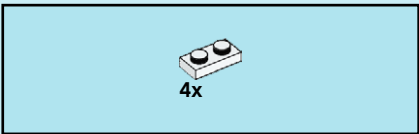

7

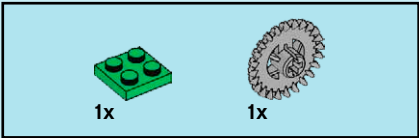
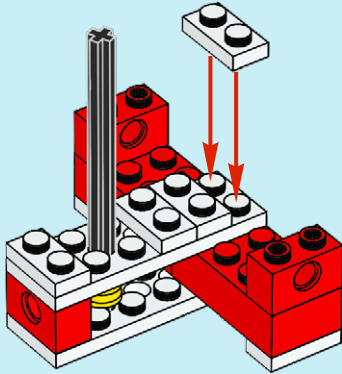

8

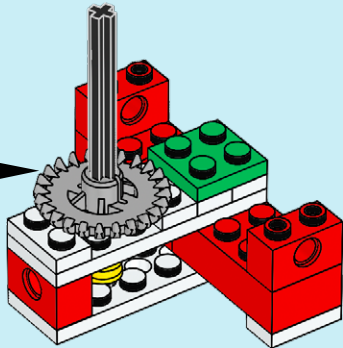
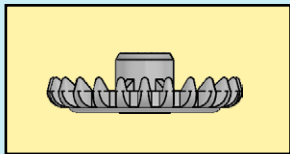

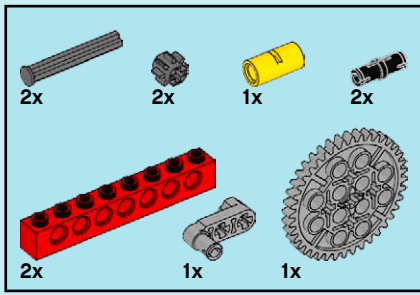

9

1

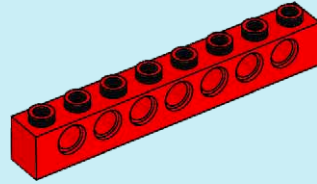

2

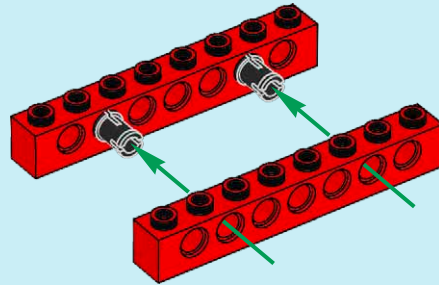

3

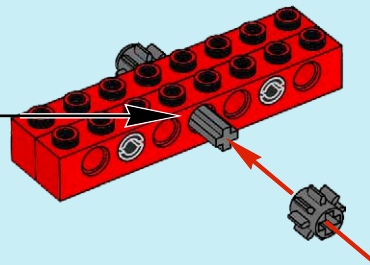
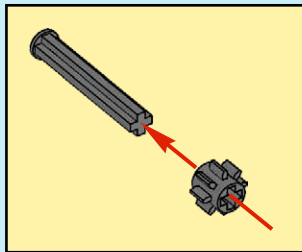

4

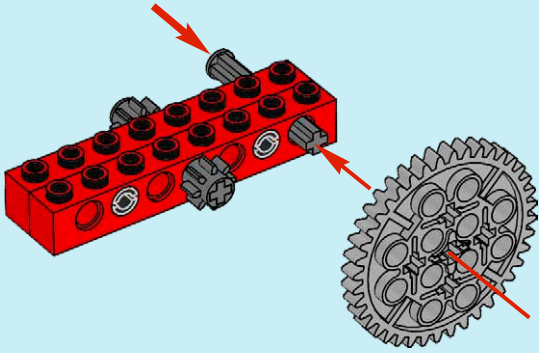

5

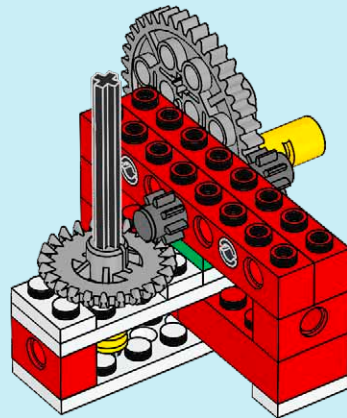
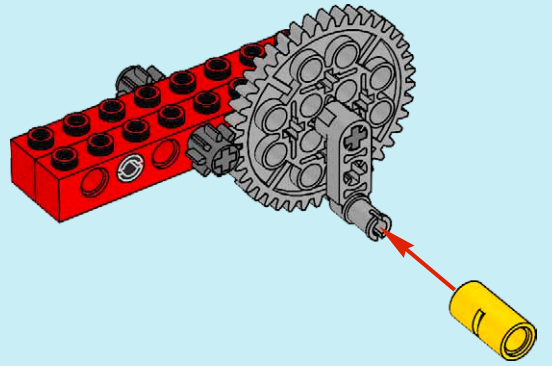

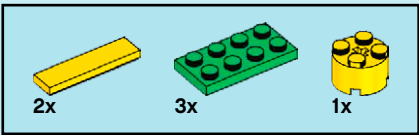

10

1

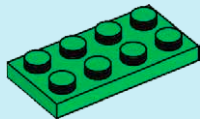

2

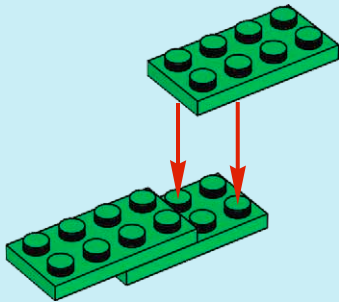

3

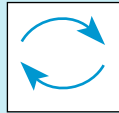
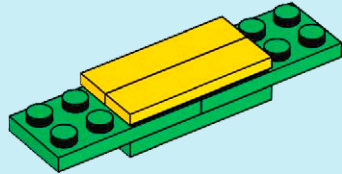

4

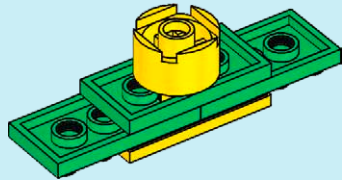

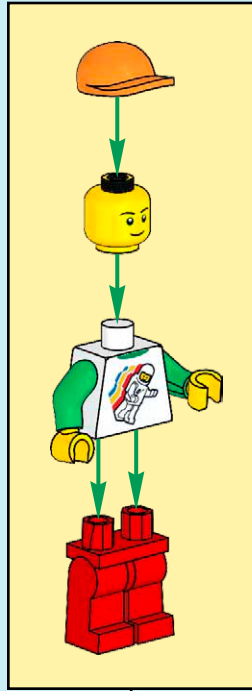
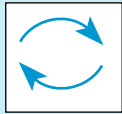

5

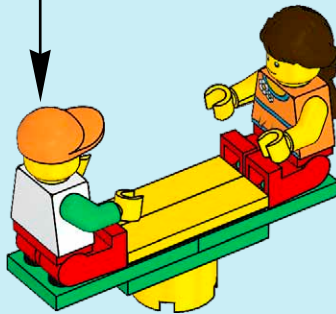

11

